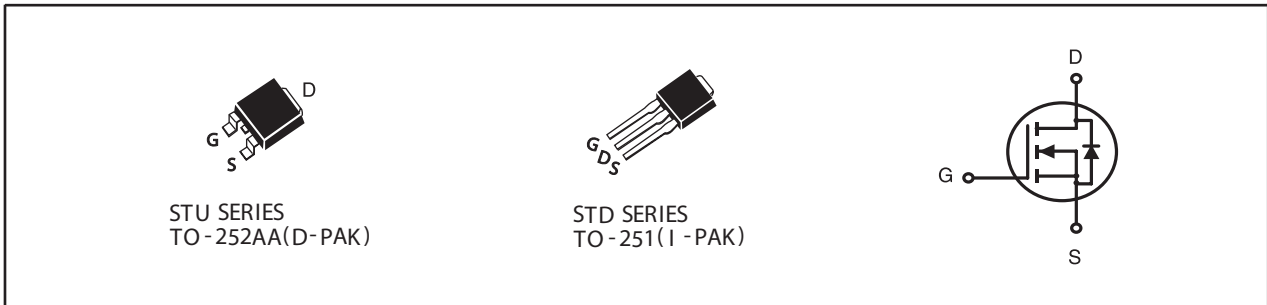

**N-Channel Logic Level Enhancement Mode Field Effect Transistor****PRODUCT SUMMARY**

VDSS	ID	RDS(ON) (mΩ) Max
100V	6A	353 @ VGS=10V
		553 @ VGS=4.5V

**FEATURES**

- Super high dense cell design for low RDS(ON).
- Rugged and reliable.
- TO-252 and TO-251 Package.

**ABSOLUTE MAXIMUM RATINGS (T<sub>C</sub>=25°C unless otherwise noted)**

Symbol	Parameter	Limit	Units
V <sub>DS</sub>	Drain-Source Voltage	100	V
V <sub>GS</sub>	Gate-Source Voltage	±20	V
I <sub>D</sub>	Drain Current-Continuous <sup>a e</sup>	T <sub>C</sub> =25°C	6
		T <sub>C</sub> =70°C	4.8
I <sub>DM</sub>	-Pulsed <sup>b</sup>	17	A
E <sub>AS</sub>	Single Pulse Avalanche Energy <sup>d</sup>	3.6	mJ
P <sub>D</sub>	Maximum Power Dissipation	T <sub>C</sub> =25°C	42
		T <sub>C</sub> =70°C	27
T <sub>J</sub> , T <sub>STG</sub>	Operating Junction and Storage Temperature Range	-55 to 150	°C

**THERMAL CHARACTERISTICS**

R <sub>θJC</sub>	Thermal Resistance, Junction-to-Case	3	°C/W
R <sub>θJA</sub>	Thermal Resistance, Junction-to-Ambient	50	°C/W

# STU06L01

## STD06L01

Ver 1.1

### ELECTRICAL CHARACTERISTICS (T<sub>C</sub>=25°C unless otherwise noted)

Symbol	Parameter	Conditions	Min	Typ	Max	Units
<b>OFF CHARACTERISTICS</b>						
BV <sub>DSS</sub>	Drain-Source Breakdown Voltage	V <sub>GS</sub> =0V , I <sub>D</sub> =10mA	100			V
I <sub>DSS</sub>	Zero Gate Voltage Drain Current	V <sub>DS</sub> =80V , V <sub>GS</sub> =0V			1	μA
I <sub>GSS</sub>	Gate-Body Leakage Current	V <sub>GS</sub> = ±20V , V <sub>DS</sub> =0V			±100	nA
<b>ON CHARACTERISTICS</b>						
V <sub>GS(th)</sub>	Gate Threshold Voltage	V <sub>DS</sub> =V <sub>GS</sub> , I <sub>D</sub> =250μA	1	2	3	V
R <sub>DS(ON)</sub>	Drain-Source On-State Resistance	V <sub>GS</sub> =10V , I <sub>D</sub> =3A		282	353	m ohm
		V <sub>GS</sub> =4.5V , I <sub>D</sub> =2A		410	553	m ohm
g <sub>FS</sub>	Forward Transconductance	V <sub>DS</sub> =10V , I <sub>D</sub> =3A		4.5		S
<b>DYNAMIC CHARACTERISTICS <sup>c</sup></b>						
C <sub>ISS</sub>	Input Capacitance	V <sub>DS</sub> =25V, V <sub>GS</sub> =0V f=1.0MHz		273		pF
C <sub>OSS</sub>	Output Capacitance			25		pF
C <sub>RSS</sub>	Reverse Transfer Capacitance			18		pF
<b>SWITCHING CHARACTERISTICS <sup>c</sup></b>						
t <sub>D(ON)</sub>	Turn-On Delay Time	V <sub>DD</sub> =50V I <sub>D</sub> =1A V <sub>GS</sub> =10V R <sub>GEN</sub> = 6 ohm		8.5		ns
t <sub>r</sub>	Rise Time			9.6		ns
t <sub>D(OFF)</sub>	Turn-Off Delay Time			15.2		ns
t <sub>f</sub>	Fall Time			2.5		ns
Q <sub>g</sub>	Total Gate Charge	V <sub>DS</sub> =50V, I <sub>D</sub> =3A, V <sub>GS</sub> =10V		4.3		nC
Q <sub>gs</sub>	Gate-Source Charge	V <sub>DS</sub> =50V, I <sub>D</sub> =3A, V <sub>GS</sub> =10V		1		nC
Q <sub>gd</sub>	Gate-Drain Charge			1.6		nC
<b>DRAIN-SOURCE DIODE CHARACTERISTICS AND MAXIMUM RATINGS</b>						
V <sub>SD</sub>	Diode Forward Voltage	V <sub>GS</sub> =0V, I <sub>S</sub> =1A		0.8	1.3	V
<b>Notes</b>						
a.Surface Mounted on FR4 Board, t ≤ 10sec.						
b.Pulse Test:Pulse Width ≤ 300us, Duty Cycle ≤ 2%.						
c.Guaranteed by design, not subject to production testing.						
d.Starting T <sub>J</sub> =25°C, L=0.5mH, V <sub>DD</sub> = 50V.(See Figure13)						
e.Drain current limited by maximum junction temperature.						

Oct,30,2013

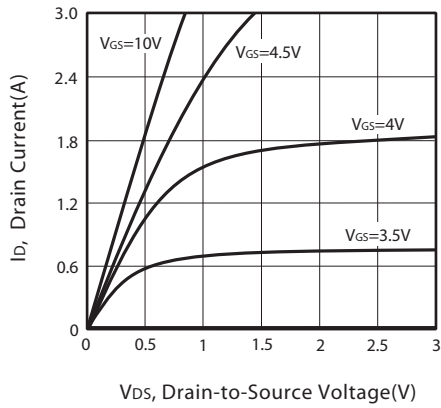

Figure 1. Output Characteristics

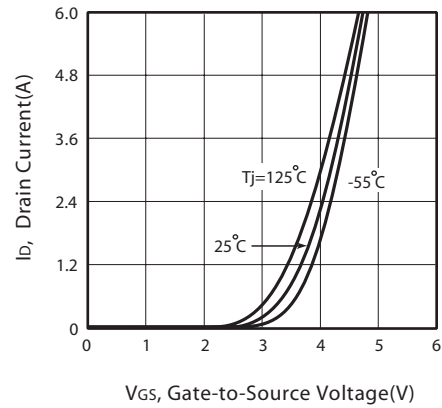

Figure 2. Transfer Characteristics

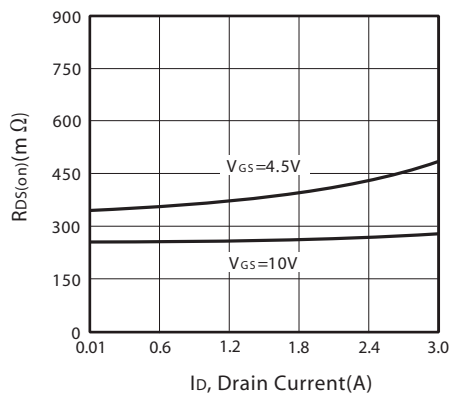

Figure 3. On-Resistance vs. Drain Current and Gate Voltage

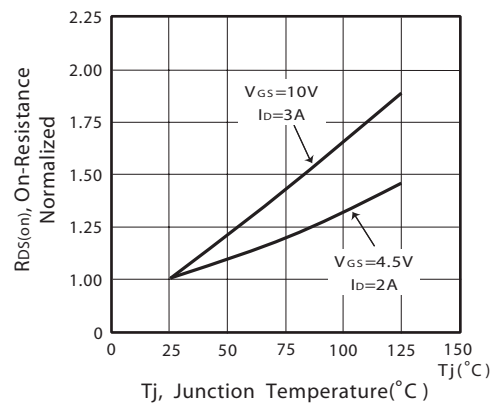

Figure 4. On-Resistance Variation with Drain Current and Temperature

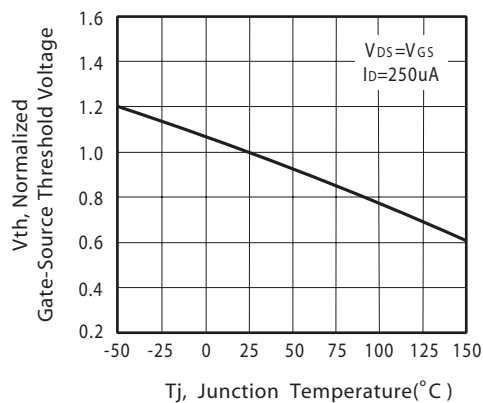

Figure 5. Gate Threshold Variation with Temperature

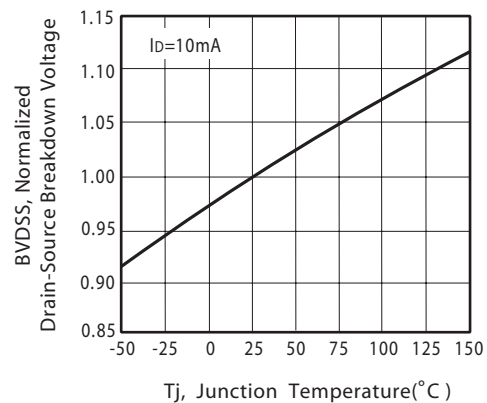

Figure 6. Breakdown Voltage Variation with Temperature

# STU06L01 STD06L01

Ver 1.1

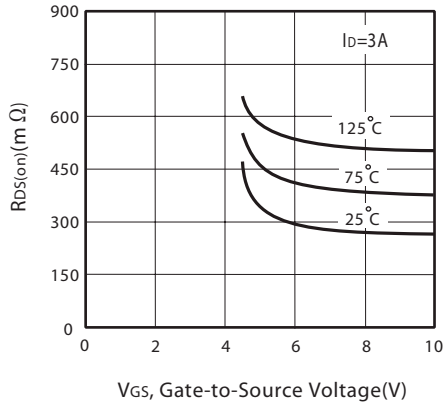

Figure 7. On-Resistance vs. Gate-Source Voltage

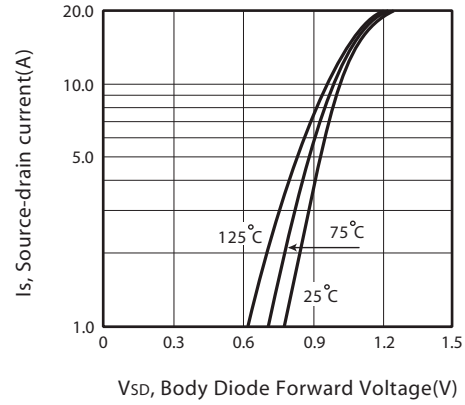

Figure 8. Body Diode Forward Voltage Variation with Source Current

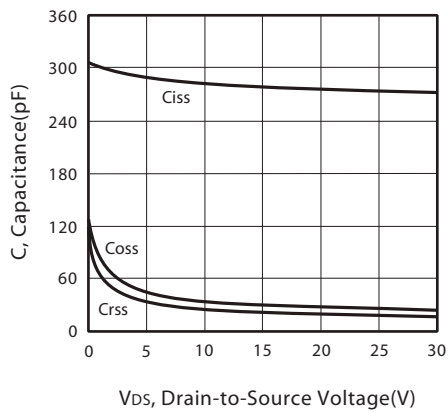

Figure 9. Capacitance

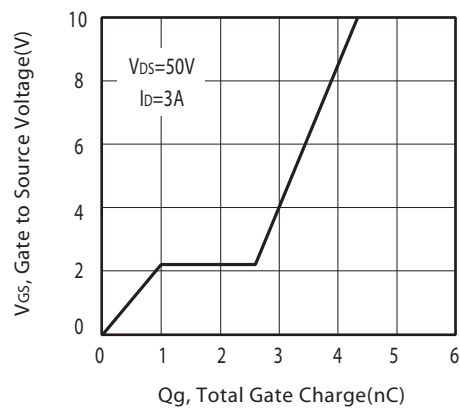

Figure 10. Gate Charge

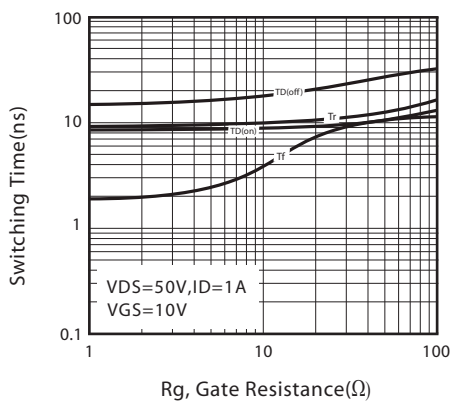

Figure 11. switching characteristics

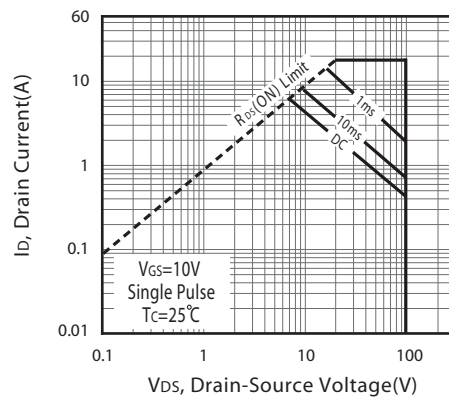
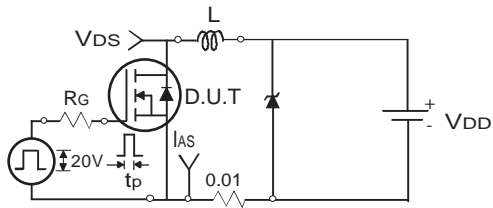

Figure 12. Maximum Safe Operating Area

Oct,30,2013

# STU06L01 STD06L01



Uncamped Inductive Test Circuit

Figure 13a.

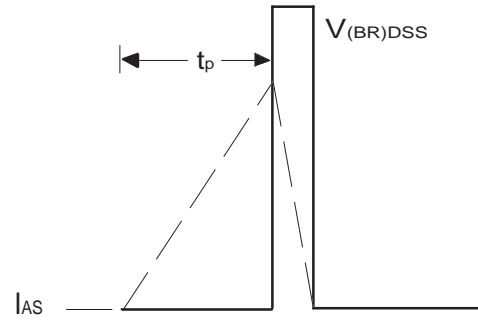

Uncamped Inductive Waveforms

Figure 13b.

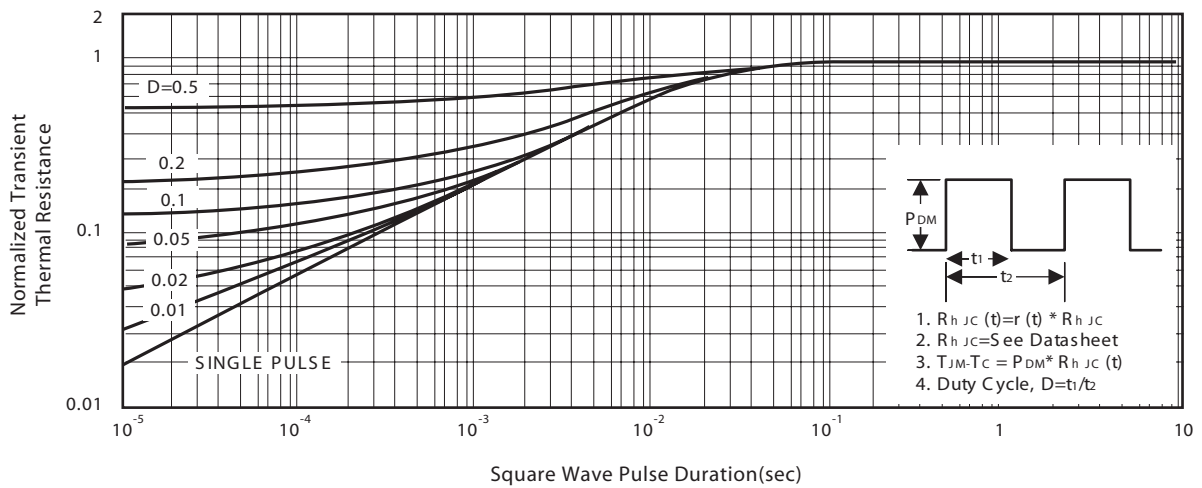
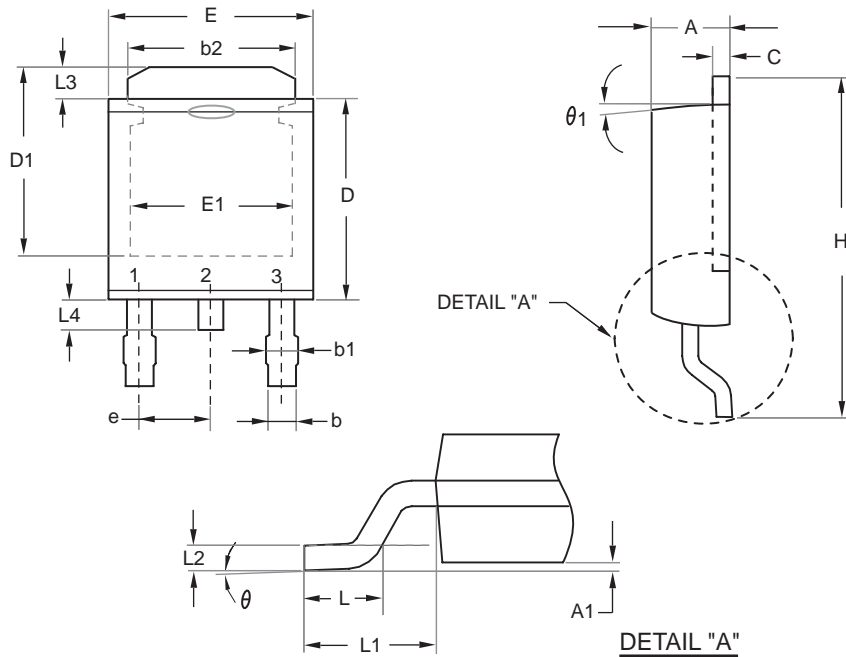

Figure 14. Normalized Thermal Transient Impedance Curve

# STU06L01 STD06L01

Ver 1.1

TO-252



SYMBOLS	MILLIMETERS		INCHES	
	MIN	MAX	MIN	MAX
A	2.100	2.500	0.083	0.098
A1	0.000	0.200	0.000	0.008
b	0.400	0.889	0.016	0.035
b1	0.770	1.140	0.030	0.045
b2	4.800	5.460	0.189	0.215
C	0.400	0.600	0.016	0.024
D	5.300	6.223	0.209	0.245
D1	4.900	5.515	0.193	0.217
E	6.300	6.731	0.248	0.265
E1	4.400	5.004	0.173	0.197
e	2.290 REF		0.090 BSC	
H	8.900	10.400	0.350	0.409
L	1.397	1.770	0.055	0.070
L1	2.743 REF.		0.108 REF.	
L2	0.508 REF.		0.020 REF.	
L3	0.890	1.700	0.035	0.067
L4	0.500	1.100	0.020	0.043
theta	0°	10°	0°	10°
theta1	7° REF.		7° REF.	

Oct,30,2013

# STU06L01

## STD06L01

Ver 1.1

### PACKAGE OUTLINE DIMENSIONS

TO-251

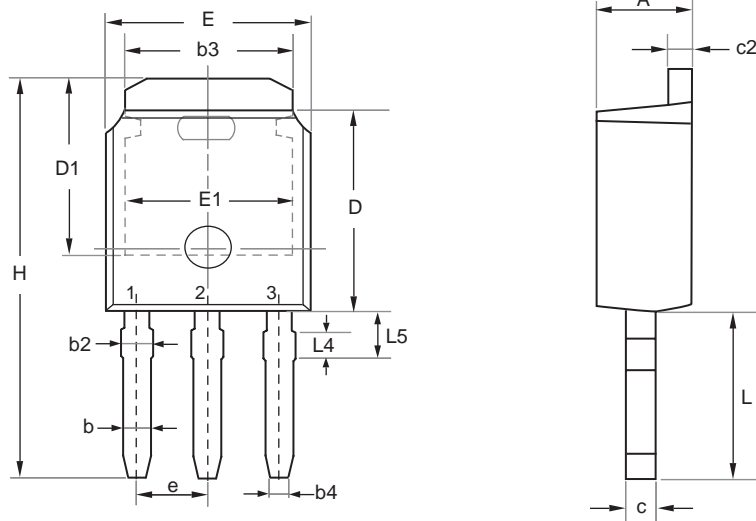

SYMBOL	MILLIMETERS		INCHES	
	MIN	MAX	MIN	MAX
E	6.400	6.731	0.252	0.265
L	3.980	4.280	0.157	0.169
L4	0.698 REF		0.027 REF	
L5	0.972	1.226	0.038	0.048
D	6.000	6.223	0.236	0.245
H	11.050	11.450	0.435	0.450
b	0.640	0.880	0.025	0.035
b2	0.770	1.140	0.030	0.045
b3	5.210	5.460	0.205	0.215
b4	0.450	0.550	0.018	0.022
e	2.286 BSC		0.090 BSC	
A	2.200	2.380	0.087	0.094
c	0.400	0.600	0.016	0.024
c2	0.400	0.600	0.016	0.024
D1	5.100	---	0.201	---
E1	4.400	---	0.173	---

Oct,30,2013

# STU06L01 STD06L01

Ver 1.1

## TO-251 Tube/TO-252 Tape and Reel Data

### TO-251 Tube

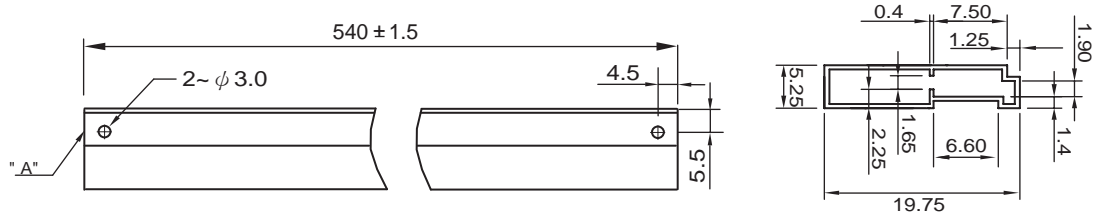

### TO-252 Carrier Tape

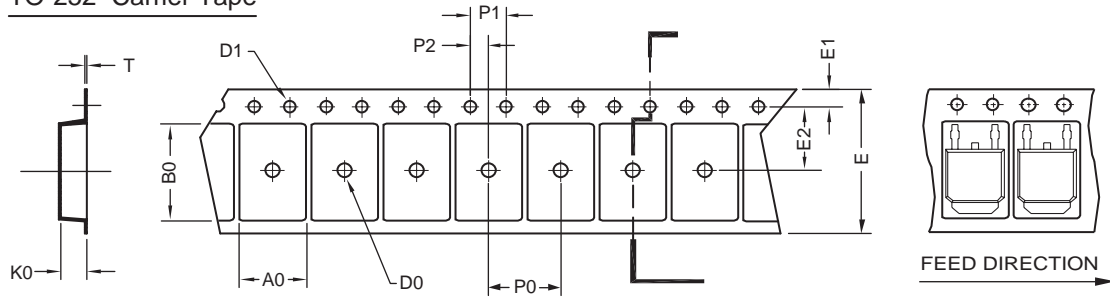

UNIT:mm

PACKAGE	A0	B0	K0	D0	D1	E	E1	E2	P0	P1	P2	T
TO-252 (16 mm)	6.96 $\pm 0.1$	10.49 $\pm 0.1$	2.79 $\pm 0.1$	$\phi 2$	$\phi 1.5$ $+0.1$ $-0$	16.0 $\pm 0.3$	1.75 $\pm 0.1$	7.5 $\pm 0.15$	8.0 $\pm 0.1$	4.0 $\pm 0.1$	2.0 $\pm 0.15$	0.3 $\pm 0.05$

### TO-252 Reel

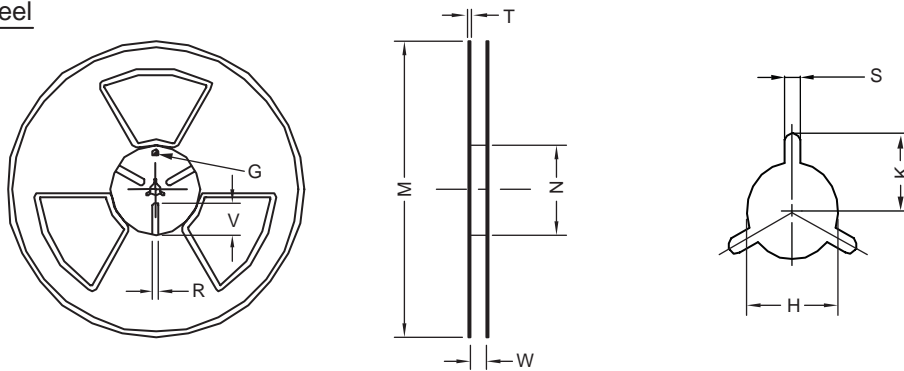

UNIT:mm

TAPE SIZE	REEL SIZE	M	N	W	T	H	K	S	G	R	V
16 mm	$\phi 330$	$\phi 330$ $\pm 0.5$	$\phi 97$ $\pm 1.0$	17.0 $+1.5$ $-0$	2.2	$\phi 13.0$ $+0.5$ $-0.2$	10.6	2.0 $\pm 0.5$	---	---	---

Oct,30,2013



# STU06L01 STD06L01

Ver 1.1

## TOP MARKING DEFINITION

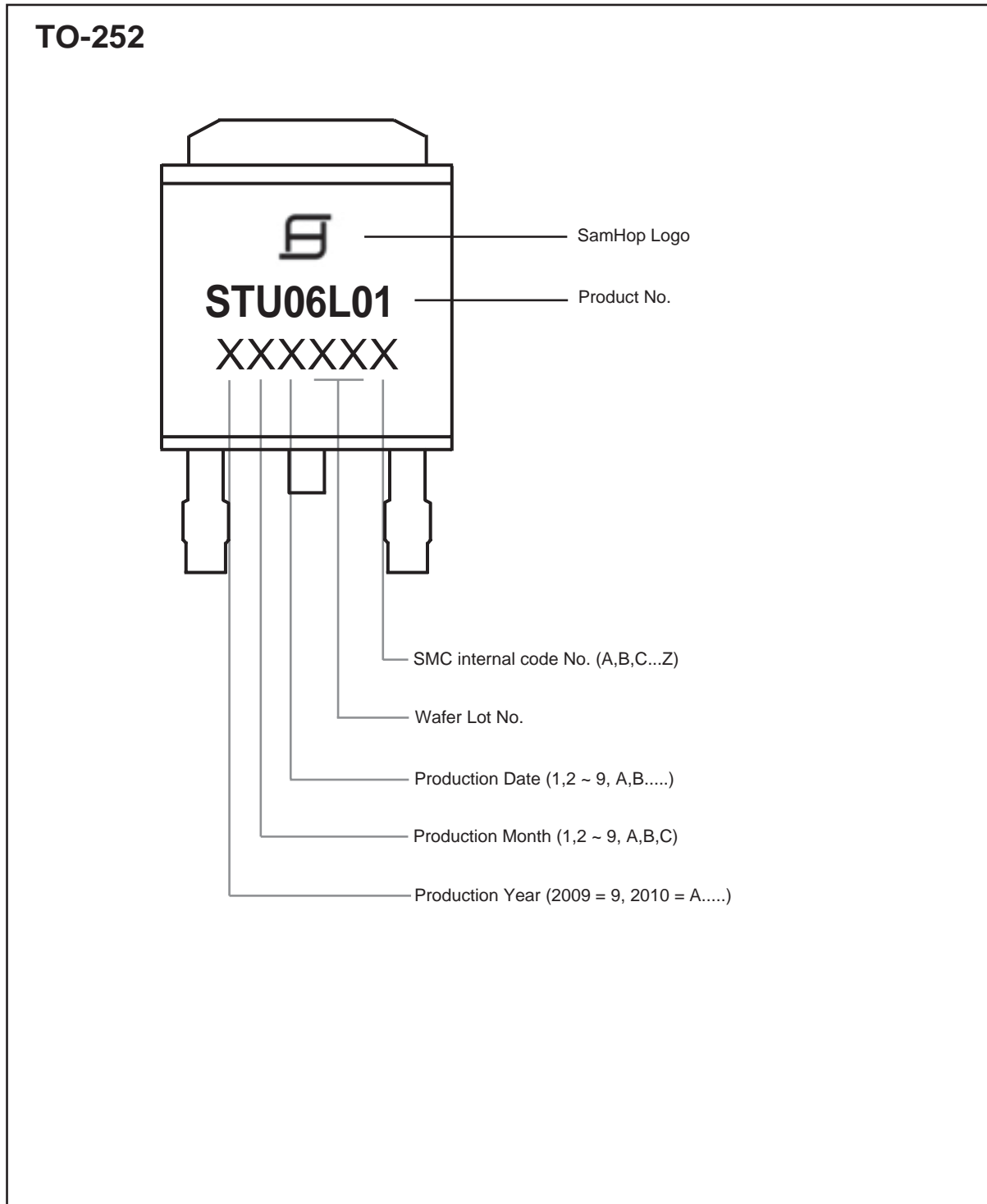

Oct,30,2013

# STU06L01 STD06L01

## TOP MARKING DEFINITION

